



Models: AF-LMF, AF-LMF/R, AF-LMF/RD, AF-LMF-RVS INSTALLATION AND OPERATION INSTRUCTIONS

IF YOU CANNOT READ OR UNDERSTAND THESE INSTALLATION INSTRUCTIONS DO NOT ATTEMPT TO INSTALL OR OPERATE

INTRODUCTION

These instructions apply to LMF-Series valve kits: These Natural gas safety pilot kits are designed to be used with 18 to 30-inch gas logs sets purchased separately as a complete valve kit. These control systems were developed to provide safe, reliable, user-friendly remote control system for gas heating appliances.

Optional LP conversion kits LPK-18, LPK-24 with pilot orifices are available.

Important: Read these instructions carefully before starting installation of your log set.

- What to do if you smell gas?**
- Do not try to light the appliance
 - Do not touch any electrical switch
 - Do not use any phone in your building
 - Immediately call your gas supplier from a neighbor's phone. Follow the gas suppliers instructions.
 - If you cannot reach your gas supplier, call the fire department.

Warning: Improper installation, adjustment, alteration, service or maintenance can cause injury or property damage. Refer to this manual. For assistance or additional information consult a qualified installer, service agency or gas supplier.

For Your Safety: Do not store or use gasoline or other flammable vapors and liquids in the vicinity of this or any other appliance.

Notice: Please leave these instructions for the consumer. Retain for future reference.

Young children should be carefully supervised when they are in the same room as the appliance.

Be sure flue damper and glass doors are fully open when operating any vented gas log set.

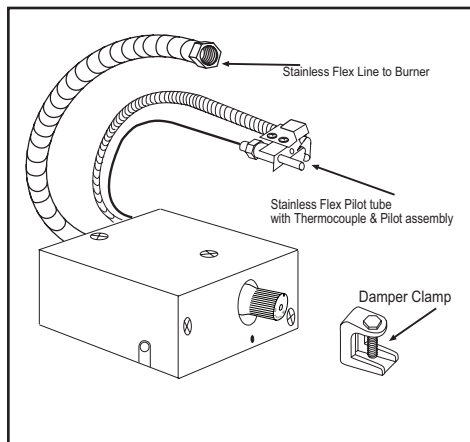

AF-LMF
Manual ON/OFF Gas Valve

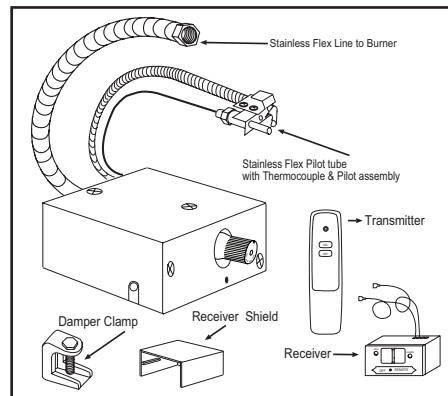

AF-LMF/R
Manual ON/OFF Gas Valve with Solenoid and ON/OFF Remote

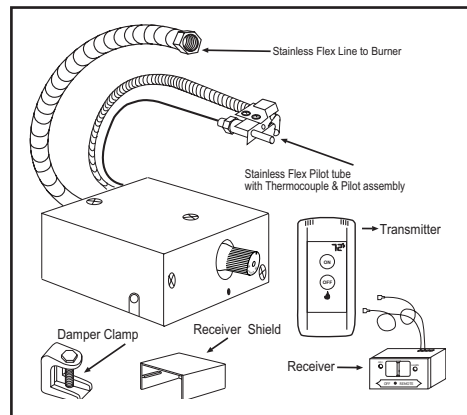

AF-LMF/RD
Manual ON/OFF Gas Valve with Solenoid and ON/OFF (Touch Screen) Remote

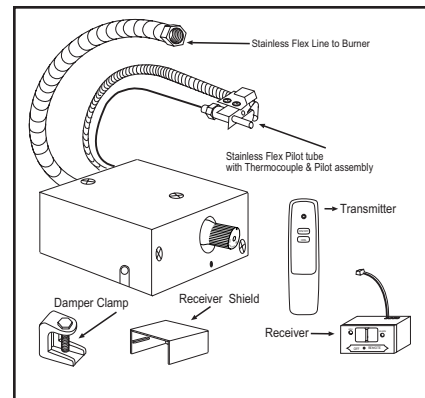

AF-LMF/RVS
Manual ON/OFF Gas Valve with Step Motor and ON/OFF (Hi/Med/Lo) Remote



WARNING

This control system must be installed exactly as outlined in these instructions. Read all instructions completely before attempting installation. Follow instructions carefully during installation. Any modifications of this control or any of its components will void the warranty and may pose a fire hazard.

These instructions must be used as a supplement to the instructions supplied with the gas log set. Follow the gas log instructions supplied by the manufacturers on the placement of the burner pan, log basket grate, burner media (sand or vermiculite), ember material and the log placement. Please follow these instructions on the connection of the inlet line to the gas valve and then to the burner pan assembly.

If your fireplace installation has glass doors, only operate the fireplace with glass doors in the fully open position.

INSTALLATION: VALVE KIT WITH PRE-EXISTING LOG SET

1. Make sure all gas flow is completely turned **OFF** to the gas log set. Make sure you have a certified and approved shut-off within 6-feet of the fireplace, or follow local code requirements.
2. Remove all logs and basket grate and set aside.
3. Disconnect the 3/8" Flared fitting at the existing manual valve from the inlet gas supply.
4. Remove existing manual valve and fittings on the burner pan.
5. Locate a position on the back of the burner pan about 4-inches from the right or left side of the burner pan. (Figure #1 & #2)
6. Mount pilot assembly to burner pan as shown in Figure # 3. Note this pilot bracket clips on the burner pan and holds the pilot at a 45-degree position onto the pan with no screws required. A screw can be added to secure the pilot assembly if needed. Bend 1/4" stainless pilot tubing from pilot assembly until the bottom of the pilot bracket is resting against the pan. (This will hold the pilot at the 45 degree position) then connect pilot fitting to valve. **(Use caution when bending pilot tubing not to kink the tubing or locate the tubing in or over the burner pan).**
7. Locate the valve kit in the right or left front corner of the firebox as far forward as possible (See Figure #4).
8. Bend inlet gas supply line and connect the 3/8" flare fitting to gas valve 3/8" inlet connector (Fitting with printed label) (Use caution not to kink the line when bending).
9. Bend 12" stainless flex line and connect to valve outlet then connect other end to 3/8" flare fitting on burner pan **(Caution do not let gas inlet line to the valve kit or gas outlet line from the valve kit be placed in or over the burner pan).**
10. Turn ON gas supply and check all connections for leaks using soapy water solution.
11. Follow valve pilot lighting instructions. After pilot is lit, check pilot fittings for leaks.
12. Reinstall basket grate and logs.
13. Install Damper stop (supplied with this valve kit) (This allows damper to remain slightly open to allow the pilot to vent)

CAUTION: On all PROPANE installations it is recommended that an inlet pressure regulator be used.

INSTALLATION: VALVE KIT WITH NEW LOG SET

1. Make sure all gas flow is completely turned **OFF** to the fireplace. Make sure you have a certified and approved shut-off within 6-feet of the fireplace, or follow local code requirements.
2. Follow the instructions supplied with the log set to locate the burner pan. Using the fittings, orifice and gas supply line that came with the log set, connect the line to the inlet gas supply.
3. Locate a position on the back of the burner pan about 4-inches from the right or left side of the burner pan. Note: (Figure #1 & #2)
4. Mount pilot assembly to burner pan as shown in (Figure #3). Note this pilot bracket clips on the burner pan and holds the pilot at a 45-degree position onto the pan and no screws required. Note: A screw can be added to secure the pilot assembly if needed. Bend 1/4" stainless pilot tubing from pilot assembly until the bottom of the pilot bracket is resting against the pan. (This will hold the pilot at the 45 degree position) then connect pilot fitting to valve. **(Use caution when bending pilot tubing not to kink the tubing or locate the tubing in or over the burner pan)**
5. Locate the valve kit in the right or left front corner of the firebox as far forward as possible (See Figure #4)
6. Bend inlet gas supply line and connect the 3/8" flare fitting to gas valve 3/8" inlet connector **(Fitting with printed label) (Use caution not to kink the line when bending).**
7. Bend 12" stainless flex line and connect to valve outlet then connect other end to 3/8" flare fitting on burner pan (Caution do not let gas inlet line to the valve kit or gas outlet line from the valve kit be placed in or over the burner pan).
8. Turn ON gas supply and check all connections for leaks using soapy water solution.
9. Follow valve pilot lighting instructions. After pilot is lit check pilot fittings for leaks.
10. Follow the instructions supplied with the log set to install ember material, basket grate and logs.
11. Install Damper stop (supplied with this valve kit) (This allows damper to remain slightly open to allow the pilot to vent).

CAUTION: On all PROPANE installations it is recommended that an inlet pressure regulator be used.

NOTE: VALVE BOX MUST BE LOCATED A MINIMUM OF 2-INCHES FROM SIDE OF THE BASKET GRATE AND NEVER PLACED DIRECTLY IN FRONT OR BEHIND THE BASKET GRATE

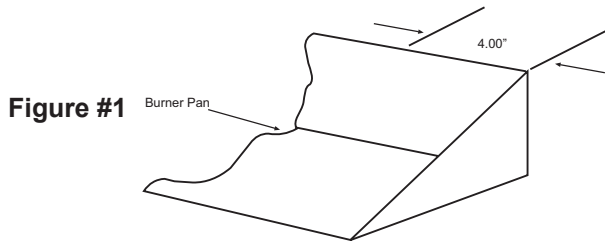

Figure #1

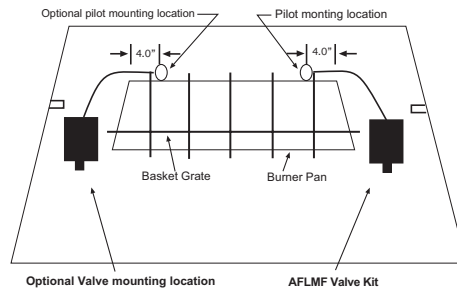

Figure #2

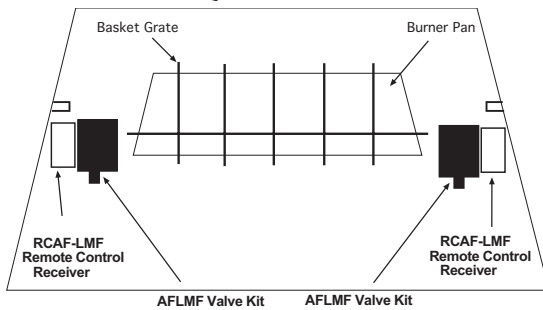

Figure #3

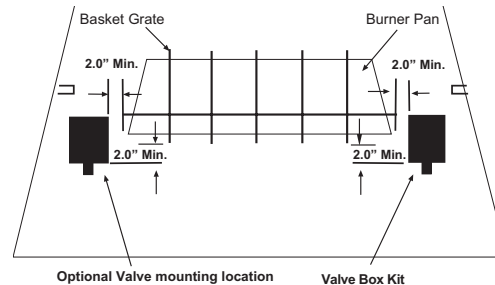

Figure #4

CONNECTING THE REMOTE CONTROL ON AF-LMF/R & AF-LMF/RD & AF-LMF-RVS VALVE KITS

1. The remote control receiver is to be placed next to the valve kit, away from the fire (Note: Figure #5).
2. Remove receiver shield and battery cover then install (4) AA alkaline batteries. Reinstall receiver shield.
3. Connect the red and black wires from the ON/OFF latching solenoid on the valve to the red and black wires from the remote receiver. If installing the AF-LMF-RVS connect the 4-pin connector from the step motor to the remote receiver (Figure #6).
4. Refer to the instructions supplied with the remote control for operation of the remote control.

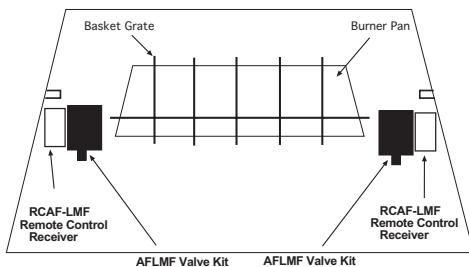

Figure #5

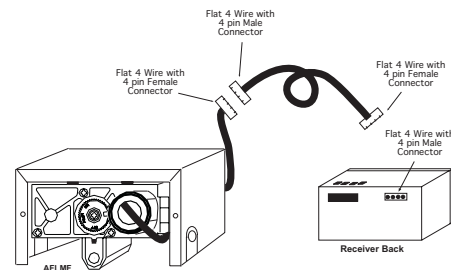

Figure #6

LIGHTING & SHUT OFF PROCEDURES

WARNING: IF YOU DO NOT FOLLOW THESE INSTRUCTIONS EXACTLY, A FIRE OR EXPLOSION MAY RESULT CAUSING PROPERTY DAMAGE, PERSONAL INJURY OR LOSS OF LIFE.

- This product has a standing pilot, which must be lit by hand. When lighting the pilot, follow these instructions exactly.
- This product should be installed including provisions for combustion and ventilation air, must conform with local codes or, in the absence of local codes, to the National Fuel Gas Code, ANSI Z223 latest addition.
- This product must be on a gas supply line that is less than 1/2 psi. and with an individual manual shut-off.
- Never operate this new system with the glass fireplace enclosures (doors) in the closed position.
- Connecting 120-volt electrical power to this product will cause damage and will void warranty.

PILOT GAS AND LIGHTING PROCEDURE

1. Turn the gas control knob counterclockwise to the **PILOT** position, push the gas control knob IN and HOLD in position. This will open the pilot valve and allows gas to flow to the pilot burner.
2. Light the pilot burner while holding the gas control knob in until a strong pilot flame is present. (Approximately 60-seconds)
3. Release the gas control knob and verify the pilot flame remains lit.
4. Turn the gas control knob clockwise to the **ON** position, The main burner valve will open and the main burner will ignite.

SHUT OFF PROCEDURE

1. To shut **OFF** the main burner while leaving the pilot **ON**, turn the gas control knob clockwise to the **PILOT** position. This action will close the main gas flow.
2. To shut **OFF** the main burner and pilot, turn the gas control knob clockwise to the **OFF** position. This action will close the main gas valve and disengage the safety pilot valve.
3. To relight the pilot, follow the steps in the Pilot Gas and Lighting Procedure section.

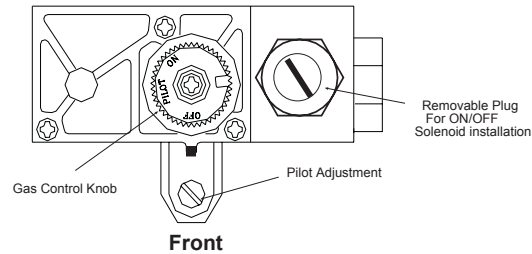
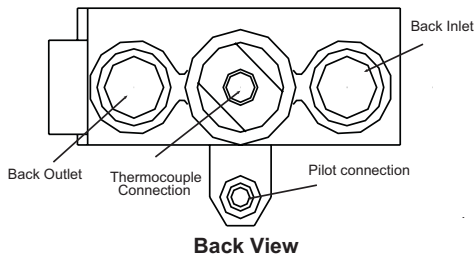

MAINTENANCE OF YOUR AF-LMF SERIES VALVE KITS

- Your system should be checked once a year (at the start of the heating season) for proper operation by a qualified serviceman.
- Items to check: Valve operation, pilot operation, switch operation, damper operation, visual check of the burner and gas connections for leaks.

PARTS LIST

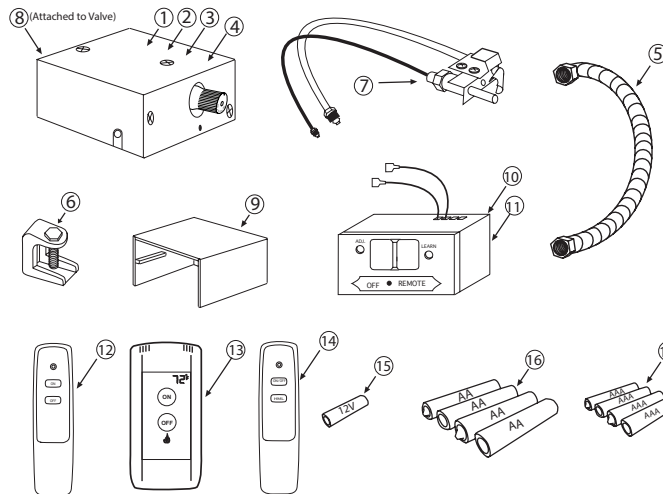

1. Manual Valve Assembly	AF-LMF
2. Remote Control Valve Assembly	AF-LMF/R
3. Gas Valve with Solenoid and Touch Screen Remote Assembly	AF-LMF/RD
4. Gas Valve with Step Motor and HML Remote Assembly	AF-LMF/RVS
5. 10-inch Black Stainless Flex Connector	T102-9898-10
6. Damper Stop	685-14
7. PSE Pilot Assembly	2385-9P
8. 3/8" Flare x 3/8" NPT Connector	685-22
9. Receiver Shield	RS-1A
10. 6-volt DC Receiver (For R & RD Models)	UN3-RX
11. 6-volt DC Receiver (For RVS Model)	RCAF-1035RX
12. ON/OFF Transmitter (AF-LMR/ Model)	CON1001TX
13. ON/OFF Transmitter (AF-LMF/RD Model)	5001TX
14. ON/OFF Hi/Med/Lo Transmitter (AF-LMF/RVS Model)	RCAF-1035TX
15. 12-volt Battery (1 Required for AF-LMF/R & RVS Transmitters)	BATT12VOLT
16. AA Battery (4 Required for AF-LMF/R & AF-LMF/RD receivers)	BATTAA
17. AAA Battery (4 Required for AF-LMF/RD Transmitter)	BATTAAA

LIMITED WARRANTY

American Flame warrants the AF-LMF Valve Kit for 12 months from the date of purchase or installation to the original purchaser to be free from defects in materials and workmanship. Damage to the AF-LMF Valve Kit caused by accident, misuse, abuse, or installation error, whether preformed by a contractor, Service Company, or owner, is not covered by this warranty. American Flame will not be responsible for labor charges and/or damage incurred in installation, repair, replacement, or for incidental or consequential damage. Some states, provinces, and nations do not allow exclusion or limitations of incidental or consequential damages, so the above limitations or exclusions may not apply. This warranty gives you specific legal rights. You may also have other rights that vary by state, province, or nation.

For Technical Service, call:

U.S. INQUIRIES

(855) 498-8324 or (260) 459-1703

Web site: www.skytechpg.com

CANADIAN INQUIRIES

(877) 472-3923

MANUFACTURED EXCLUSIVELY FOR SKYTECH II, INC. - 9230 Conservation Way, Ft. Wayne, IN 46809